

36 202 705

- deviatore a rotazione
- rosetta 60 x 60 mm



	Cromato	36 202 705-00
	Platinato spazzolato	36 202 705-06
	Dark Chrome	36 202 705-19
	Champagne spazzolato (Oro 22k)	36 202 705-46
	Champagne (Oro 22k)	36 202 705-47
	Dark Platinum spazzolato	36 202 705-99

Prodotti complementari necessari



- Deviatore a due vie incasso -** 35 202 970 90
- Profondità d'incasso max. 160 mm
 - profondità d'incasso min. 115 mm

36 202 705

mm [inches]



Diagramma di portata



Certificati

LGA_38379.

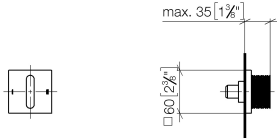
WRAS_2307045.

36 202 705

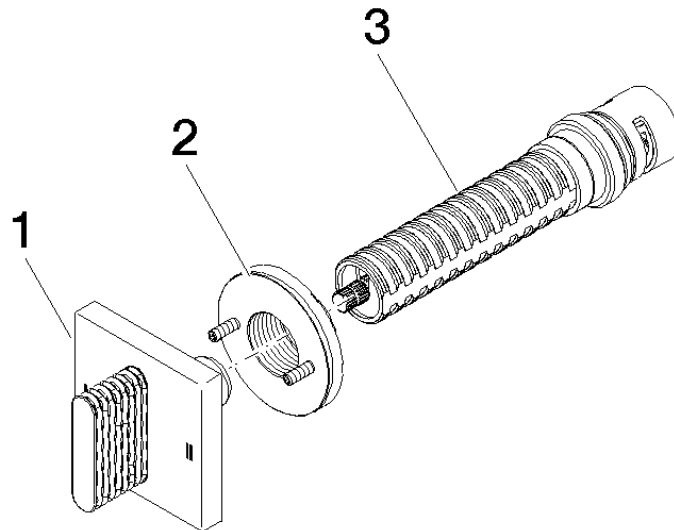

Elenco delle parti di ricambio

N.	Codice articolo	Denominazione	Quantità necessaria	Tempo di produzione
1	90 20 70 053 08-00	manopola	1	10
2	90 21 02 181 00 90	rondella	1	2
3	90 90 03 304 10 90	deviatore	1	2